

# OPERATION MANUAL

## M-thermal Wired Controller

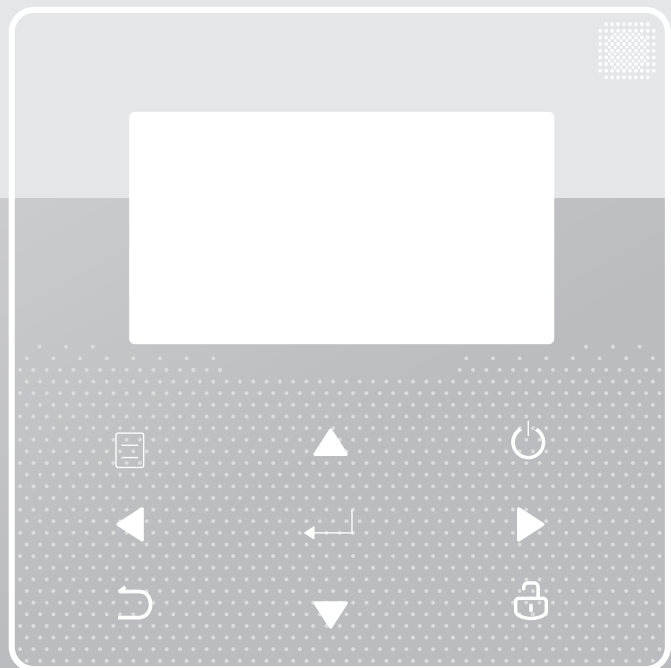

Thank you very much for purchasing our product,  
Before using your unit , please read this manual carefully and keep it for future reference.

- This manual gives detailed description of the precautions that should be brought to your attention during operation.
- In order to ensure correct service of the wired controller please read this manual carefully before using the unit.
- For convenience of future reference, keep this manual after reading it.

# CONTENTS

---

<b>1 GENERAL SAFETY PRECAUTIONS</b> .....	01
• 1.1 About the documentation.....	01
• 1.2 For the user.....	01
<b>2 A GLANCE OF THE USER INTERFACE</b> .....	02
• 2.1 The appearance of the wired controller.....	02
• 2.2 Status icons.....	02
<b>3 USING HOME PAGES</b> .....	03
<b>4 MENU STRUCTURE</b> .....	05
• 4.1 About the menu structure.....	05
• 4.2 To go to the menu structure.....	05
• 4.3 To navigate in the menu structure.....	05
<b>5 BASIC USAGE</b> .....	05
• 5.1 Screen Unlock.....	05
• 5.2 Turning ON/OFF controls.....	05
• 5.3 Adjusting the temperature.....	07
• 5.4 Adjusting space operation mode.....	08
<b>6 OPERATION</b> .....	08
• 6.1 Operation Mode.....	08
• 6.2 Preset Temperature.....	08
• 6.3 Domestic Hot Water(DHW).....	11
• 6.4 Schedule.....	13
• 6.5 Options.....	15
• 6.6 Child Lock.....	18
• 6.7 Service Information.....	18
• 6.8 Operation Parameter.....	19
• 6.9 For Serviceman.....	20
• 6.10 Network Configuration Guidelines.....	21
• 6.11 SN VIEW.....	21
<b>7 MENU STRUCTURE : OVERVIEW</b> .....	22

---

# 1 GENERAL SAFETY PRECAUTIONS

## 1.1 About the documentation

- The precautions described in this document cover very important topics, follow them carefully.

### DANGER

Indicates a situation that results in death or serious injury.

### DANGER: RISK OF ELECTROCUTION

Indicates a situation that could result in electrocution.

### DANGER: RISK OF BURNING

Indicates a situation that could result in burning because of extreme hot or cold temperatures.

### WARNING

Indicates a situation that could result in death or serious injury.

### CAUTION

Indicates a situation that could result in minor or moderate injury.

### NOTE

Indicates a situation that could result in equipment or property damage.

### INFORMATION

Indicates useful tips or additional information.

## 1.2 For the user

- If you are not sure how to operate the unit, contact your installer.

- The appliance is not intended for use by persons, including children, with reduced physical, sensory or mental capabilities, or lack of experience and knowledge, unless they have been given supervision or instruction concerning use of the appliance by a person responsible for their safety. Children must be supervised to ensure that they do not play with the product.

### CAUTION

DO NOT rinse the unit. This may cause electric shocks or fire.

- Unit are marked with the following symbol:



This means that electrical and electronic products can not be mixed with unsorted household waste. Do NOT try to dismantle the system yourself: the dismantling of the system, treatment of the refrigerant, of oil and of other parts must be done by an authorized installer and must comply with applicable legislation. Units must be treated at a specialized treatment facility for reuse, recycling and recovery. By ensuring this product is disposed of correctly, you will help to prevent potential negative consequences for the environment and human health. For more information, contact your installer or local authority.

- Placed in a location away from radiation.

## 2 A GLANCE OF THE USER INTERFACE

### 2.1 The appearance of the wired controller

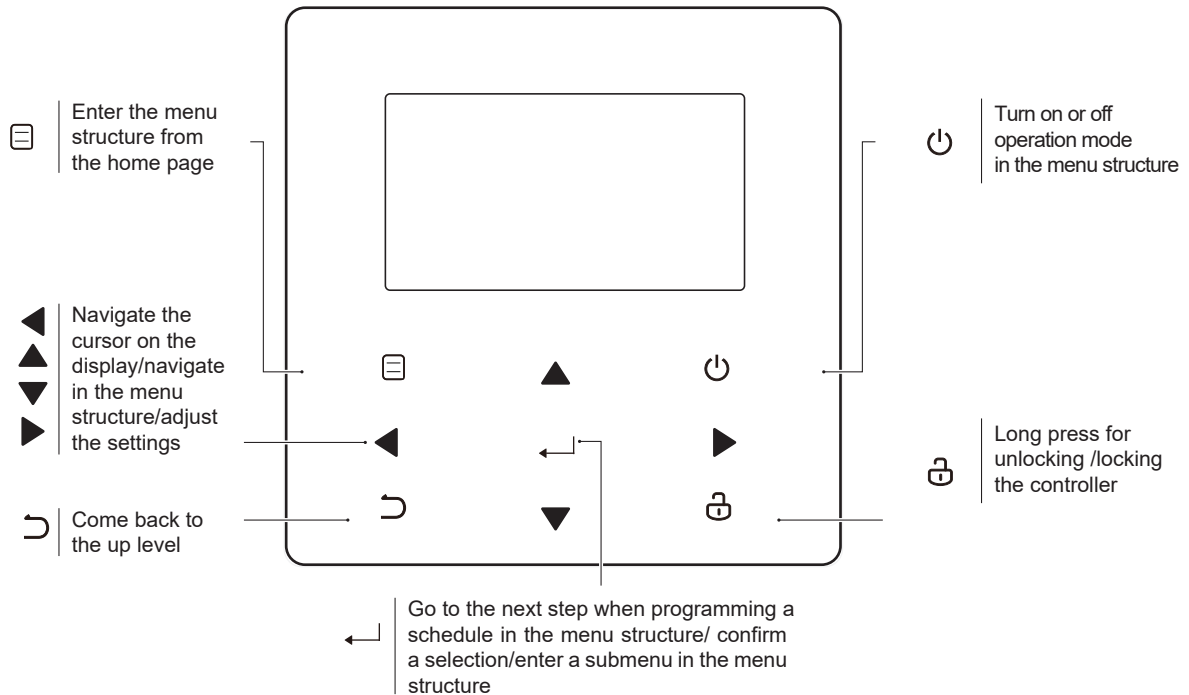

### 2.2 Status icons

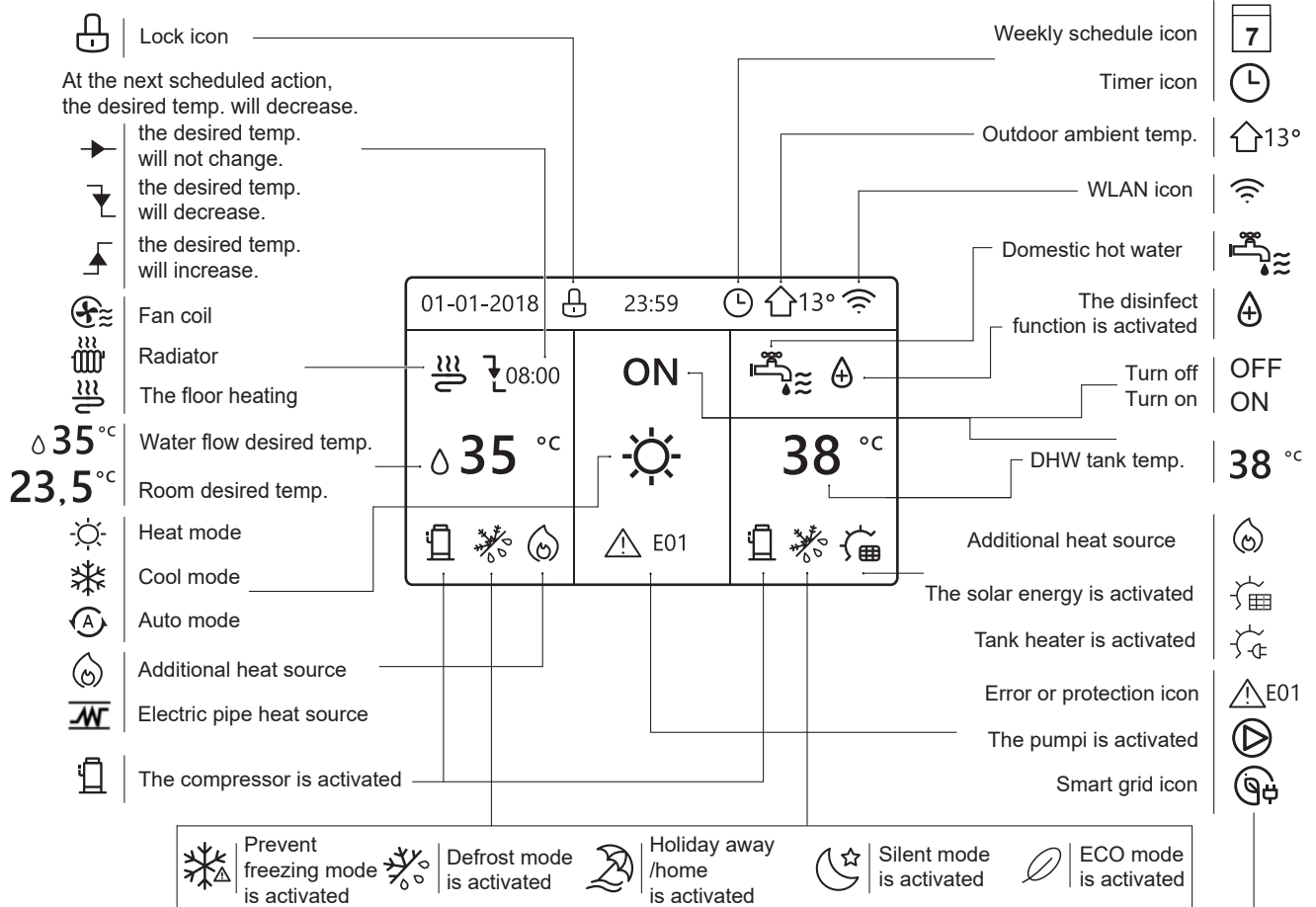

	Fan coil	Radiator	The floor heating	Domestic hot water
ON				
OFF				

	Free electricity	Valley electricity	Peak electricity
Smart grid			

### 3 USING HOME PAGES

When you turn on the wired controller, the system will enter the language selection page, You can choose your preferred language, then press  $\leftarrow$  to enter the home pages. If you don't press  $\leftarrow$  in 60 seconds, the system will enter in the currently selected language.

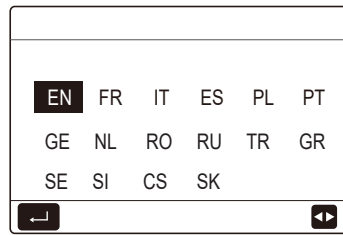

You can use the home pages to read out and change settings that are meant for daily usage. What you can see and do on the home pages is described where applicable. Depending on the system layout, the following home pages may be possible:

- Water flow desired temperature
- Room desired temperature
- Domestic hot water temperature

#### home page1 :

If the WATER FLOW TEMP. is set YES and ROOM TEMP. is set NON.(See **"FOR SERVICEMAN" > "TEMP. TYPE SETTING"** in **"Installation and owner's manual"**). The system has the function including floor heating and domestic water, home page 1 will appear:

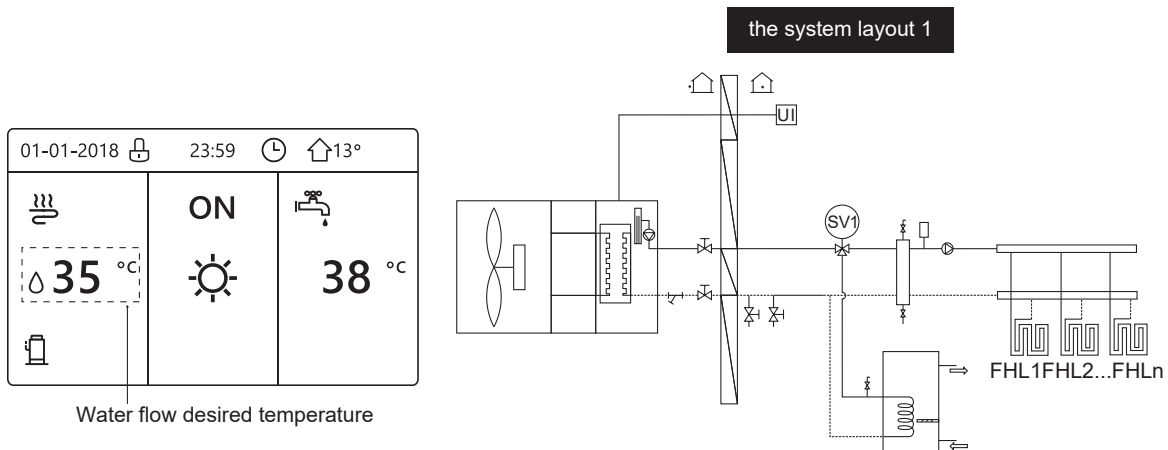

#### NOTE

All the pictures in the manual are used to explain, the actual pages in the screen may have some difference.

#### home page2 :

If the WATER FLOW TEMP. is set NON and ROOM TEMP. is set YES(See **"FOR SERVICEMAN" > "TEMP. TYPE SETTING"** on **"Installation and owner's manual"**). The system has the function including floor heating and domestic hot water, home page 2 will appear:

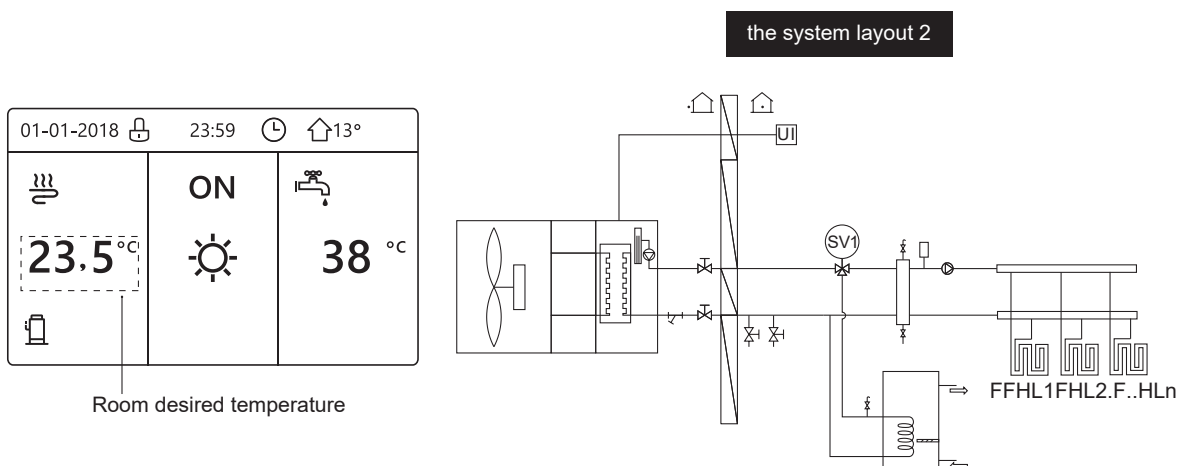

#### NOTE

The wired controller should be installed in the floor heating room to check the room temperature.

### home page3:

If the DHW MODE is set NON (See "FOR SERVICEMAN" > "DHW MODE SETTING " in "Installation and owner's manual ", and if "WATER FLOW TEMP." is set YES, "ROOM TEMP." is set YES,(See "FOR SERVICEMAN" > "TEMP. TYPE SETTING " in "Installation and owner's manual "). There will be main page and additional page. The system has the function including floor heating and space heating for fan coil, home page 3 will appear:

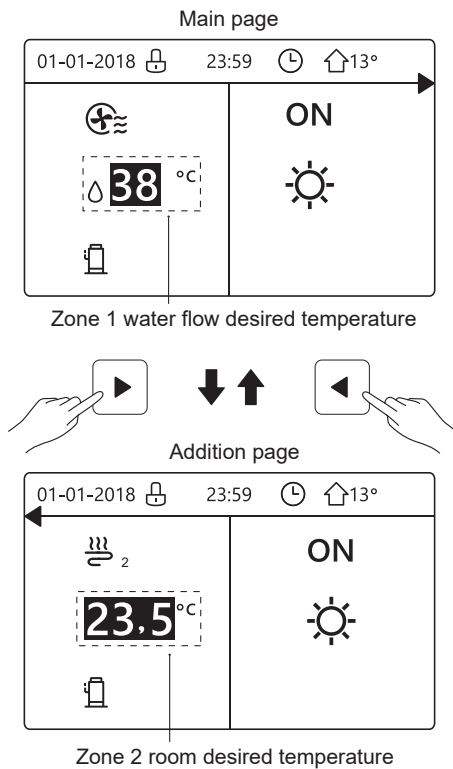

the system layout 3

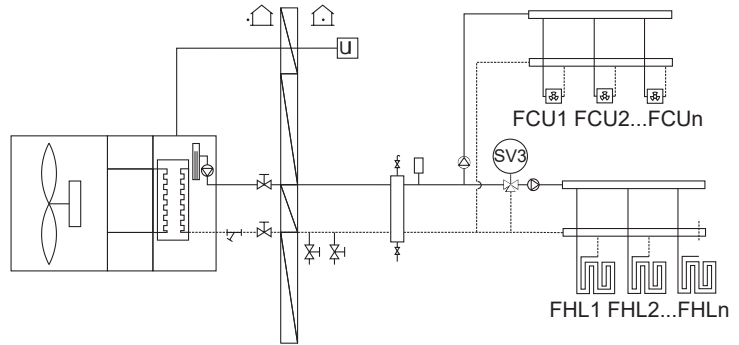

### home page4 :

If the ROOM THERMOSTAT is set DOUBLE ZONE or DOUBLE ZONE is set YES. There will be main page and addition page. The system has the function including floor heating, space heating for fan coil and domestic hot water, home page 4 will appear:

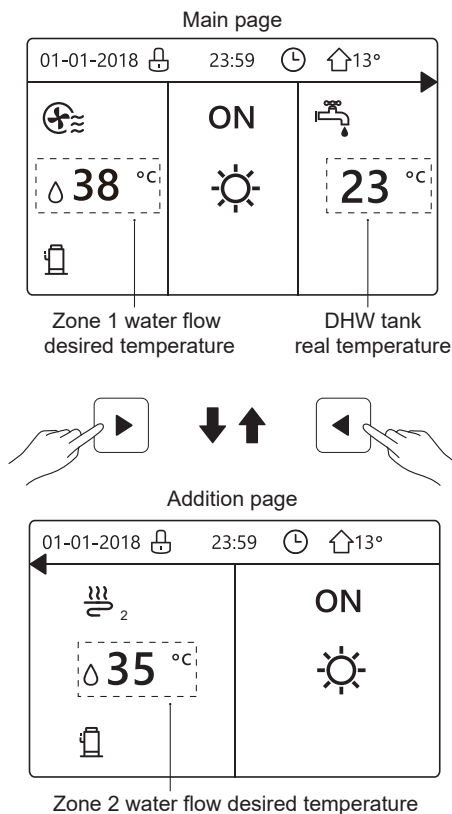

the system layout 4

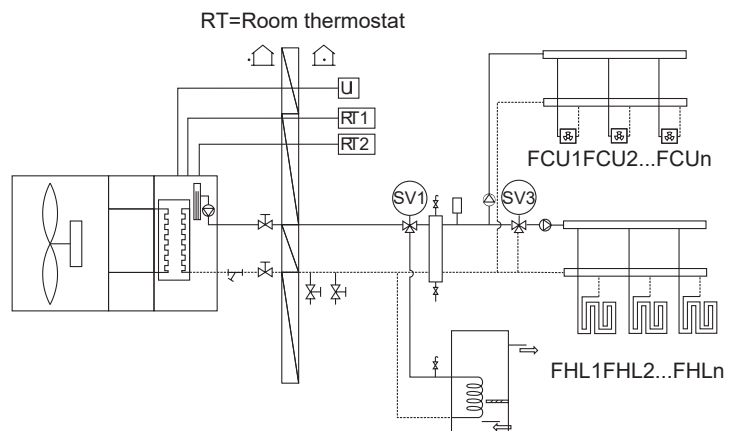

## 4 MENU STRUCTURE

### 4.1 About the menu structure

You can use the menu structure to read out and configure settings that are NOT meant for daily usage. What you can see and do in the menu structure is described where applicable. For an overview of the menu structure, see "7 Menu structure: Overview".

### 4.2 To go to the menu structure

From a home page, press "☰".

Result: The menu structure appear:

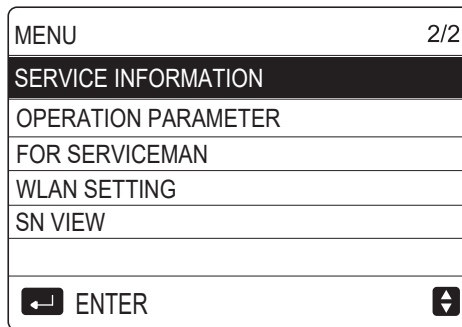
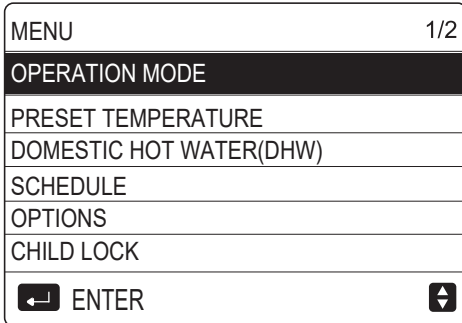

### 4.3 To navigate in the menu structure



Use "▼", "▲" to scroll.

## 5 BASIC USAGE

### 5.1 Screen Unlock

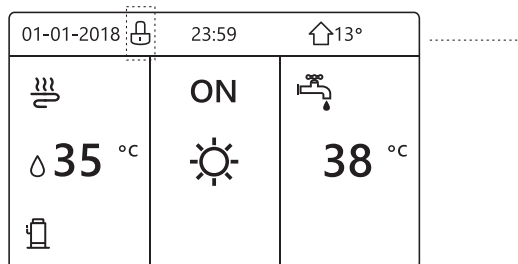
If the icon  is on the screen, the controller is locked. The following page is displayed:



Press any key, the icon  will flash. Long press the "☰" key. The icon  will disappear, the interface can be controlled.

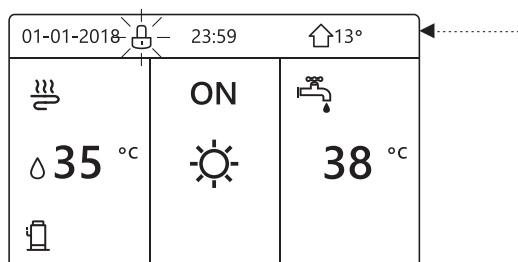

The interface will be locked if there is no handling for a long time (about 120 seconds; it can be set by the interface, see "6.7 SERVICE INFORMATION".)

If the interface is unlocked, long press "☰", the interface will be locked.

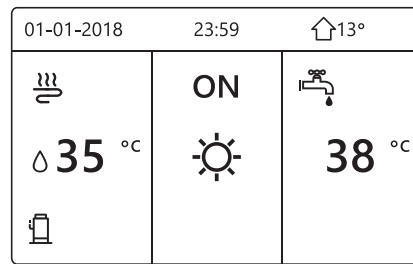

Long press  ↓ ↑ 

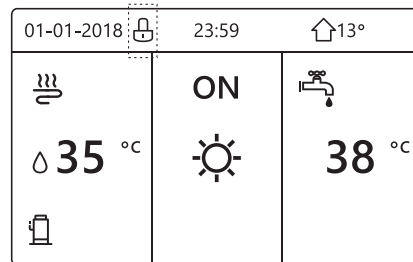



### 5.2 Turning ON/OFF controls

5.2.1 Use the interface to turn on or off the unit for space heating or cooling.

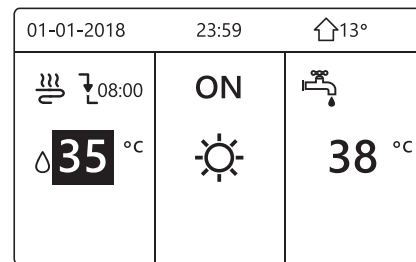
- The ON/OFF of the unit is controlled by the interface if do not activate ROOM THERMOSTAT. (see "ROOM THERMOSTAT SETTING" in "Installation and owner's manual")
- Press "◀", "▲" on home page, the black cursor will appear:



1) When the cursor is on the temperature of space operation mode side (Including heat mode , cool mode  and auto mode ) , press "ON/OFF" key to turn on/off space heating or cooling .

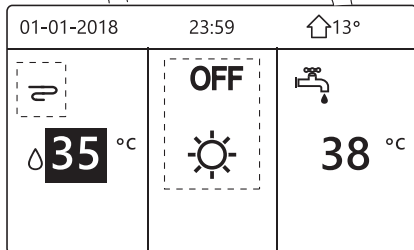
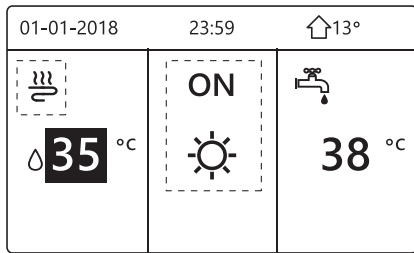

If the DHW TYPE is set NON, then following pages will display:

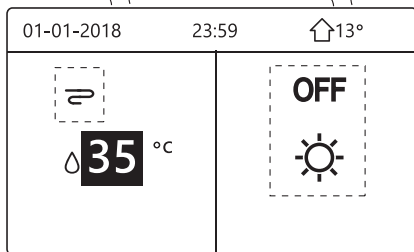
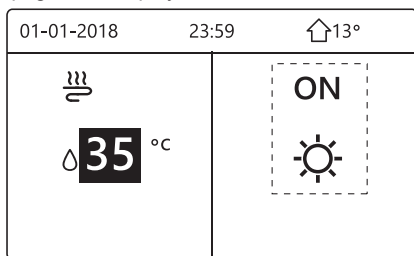

If the TEMP. TYPE is set ROOM TEMP. , then following pages will display:

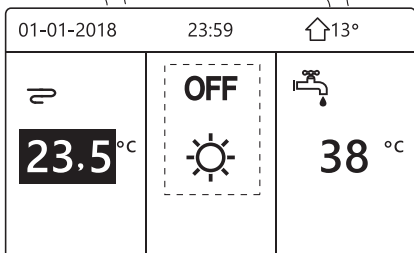
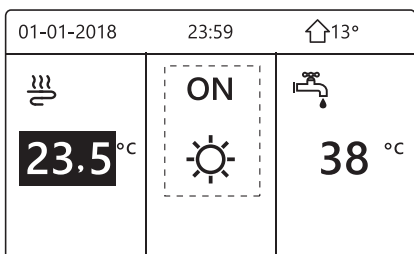

5.2.2 Use the room thermostat to turn on or off the unit for space heating or cooling.

- The room thermostat is set MODE SET (see "ROOM THERMOSTAT SETTING" in "Installation and owner's manual "). The unit operation mode and ON /OFF controlled by room thermostat , press on the interface, the following page will display:

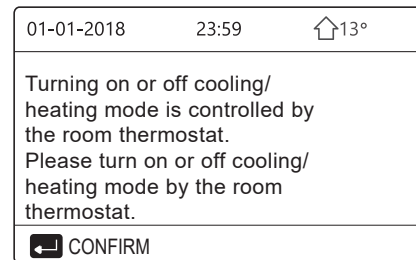

- The room thermostat is SET ONE ZONE or DOUBLE ZONE (see "ROOM THERMOSTAT SETTING" in "Installation and owner's manual "). The room thermostat control the unit ON/OFF, operation mode is set on HMI interface. The following pages show room thermostat control DOUBLE ZONE:

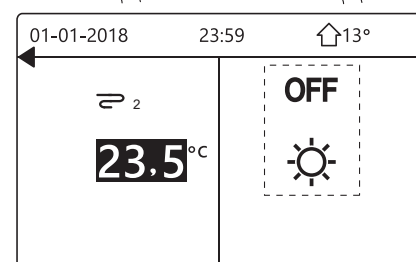
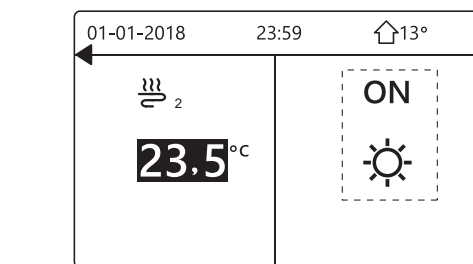
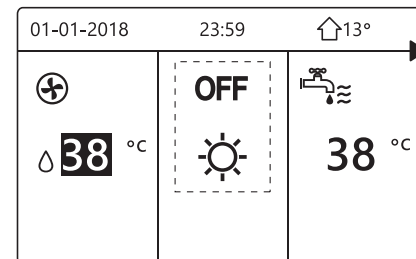
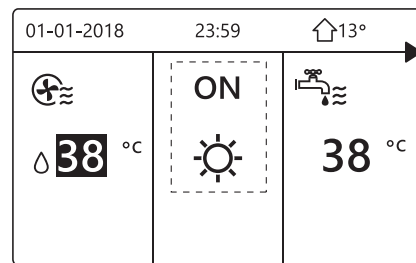



5.2.3 Use the interface to turn on or off the unit for DHW. Press "▶", "▼" on home page, the black cursor will appear:

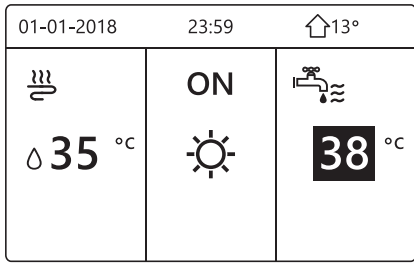

When the cursor is on the temperature of DHW mode. Press "⏻" key to turn on/off the DHW mode.

If the space operation mode is ON, then following pages will display:

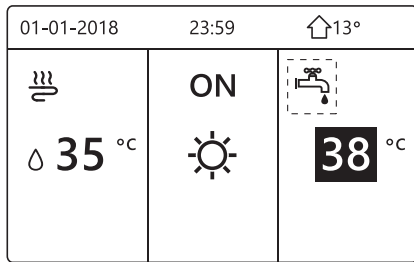
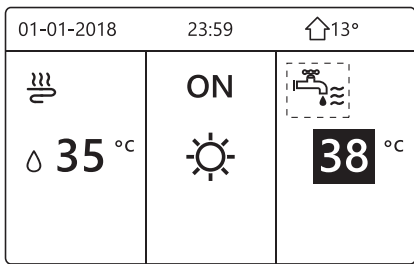

If the space operation mode is OFF, then following pages will display:

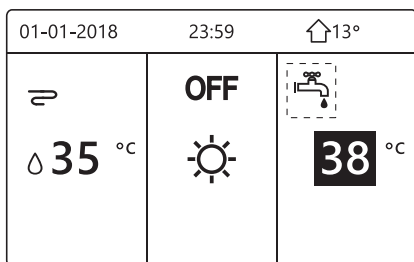
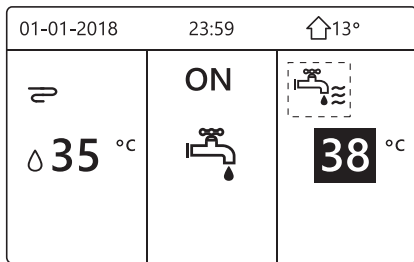

## 5.3 Adjusting the temperature

Press "◀", "▲" on home page, the black cursor will appear:

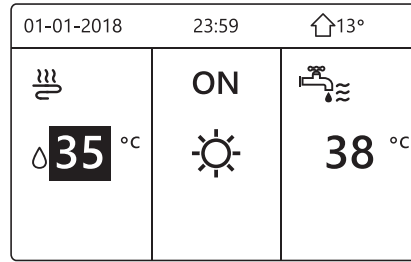

If the cursor is on the temperature, use the "◀", "▶" to select and use "▼", "▲" to adjust the temperature.

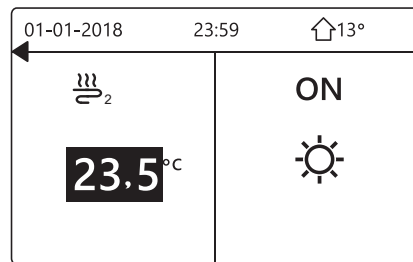
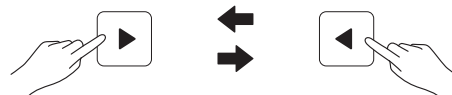
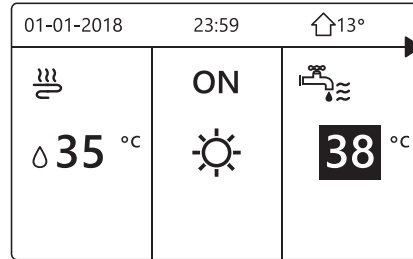
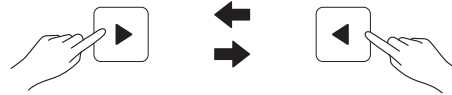
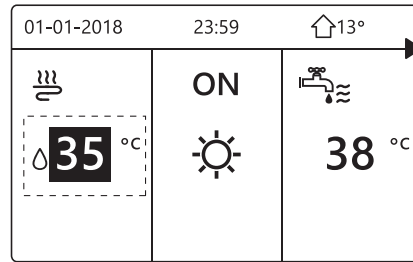

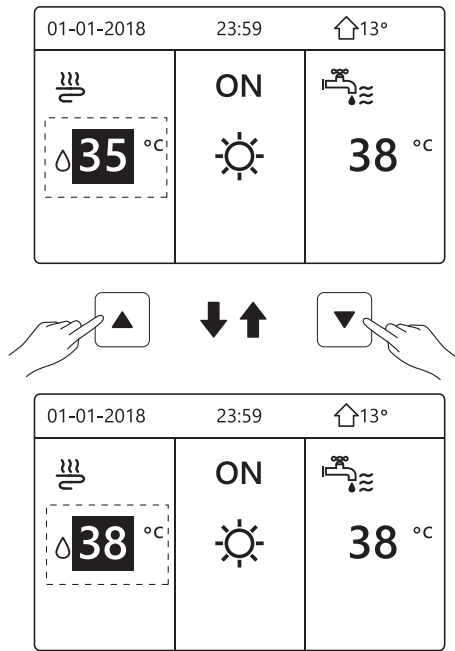

## 5.4 Adjusting space operation mode

- Adjusting space operation mode by interface  
Go to "☰" > "OPERATION MODE". Press "↵", the following page will appear:

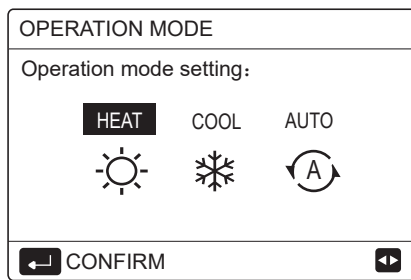

- There are three modes to be selected including HEAT, COOL and AUTO mode. Use the "◀", "▶" to scroll, press "↵" to select. Even you don't press ↵ button and exit the page by pressing ⏪ button, the mode would still be effective if the cursor had been moved to the operation mode.

If there is only HEAT(COOL) mode, the following page will appear:

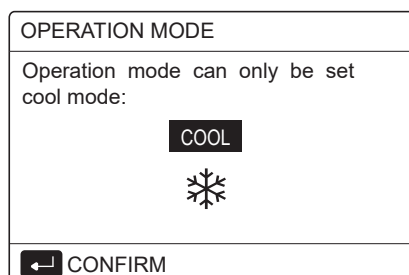
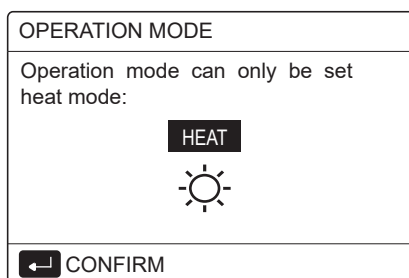

- The operation mode can not be changed.

If you select...	Then the space operation mode is...
HEAT	Always heating mode
COOL	Always cooling mode
AUTO	Automatically changed by the software based on the outdoor temperature (and depending on installer settings of the indoor temperature), and takes monthly restrictions into account. Note: Automatic changeover is only possible under certain conditions. See the "FOR SERVICEMAN"> "AUTO MODE SETTING" in "Installation and owner's manual".

- Adjust space operation mode by the room thermostat , see "ROOM THERMOSTAT" on "Installation and owner's manual".  
Go to "☰" > "OPERATION MODE", if you press any key to select or adjust, the page will appear:

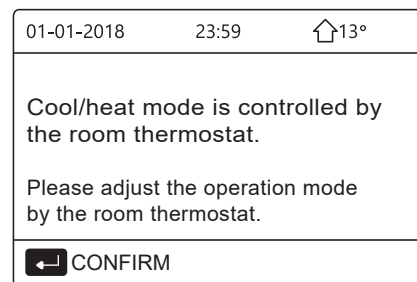

## 6 OPERATION

### 6.1 Operation Mode

See "5.4 Adjusting space operation mode"

### 6.2 Preset Temperature

PRESET TEMPERATUER has PRESET TEMP.\ WEATHER TEMP. SET\ECO MODE 3 items.

#### 6.2.1 PRESET TEMP.

PRESET TEMP. function is used to set different temperature on different time when the heat mode or cool mode is on.

- PRESET TEMP. =PRESET TEMPERATUER
- The PRESET TEMP. function will be off in these conditions.

- AUTO mode is running.
- TIMER or WEEKLY SCHEDULE is running.

- Go to "☰" > "PRESTE TEMPERATURE" > "PRESET TEMP". Press "↵".

The following page will appear:

PRESET TEMPERATURE			1/2
PRESET TEMP.	WEATHER TEMP.SET	ECO MODE	
NO.	TIME	TEMP.	
1	<input type="checkbox"/>	00:00 25°C	
2	<input type="checkbox"/>	00:00 25°C	
3	<input type="checkbox"/>	00:00 25°C	
			⬆ ⬇ ⬇ ⬆

PRESET TEMPERATURE			2/2
PRESET TEMP.	WEATHER TEMP.SET	ECO MODE	
NO.	TIME	TEMP.	
4	<input type="checkbox"/>	00:00 25°C	
5	<input type="checkbox"/>	00:00 25°C	
6	<input type="checkbox"/>	00:00 25°C	
			⬆ ⬇ ⬇ ⬆

When double zone is activated, The PRESET TEMP. function only works for zone 1.

use "◀", "▶", "▼", "▲" to scroll and use "▼", "▲" to adjust the time and the temperature.

When the cursor is on "■", as the following page:

PRESET TEMPERATURE			1/2
PRESET TEMP.	WEATHER TEMP.SET	ECO MODE	
NO.	TIME	TEMP.	
1	<input checked="" type="checkbox"/>	00:00 25°C	
2	<input type="checkbox"/>	00:00 25°C	
3	<input type="checkbox"/>	00:00 25°C	
☐ SELECT			⬆ ⬇ ⬇ ⬆

You press "↵", and the "■" becomes "☑". The timer 1 is selected.

You press "↵" again, and the "☑" becomes "■". The timer 1 is unselected.

PRESET TEMPERATURE			1/2
PRESET TEMP.	WEATHER TEMP.SET	ECO MODE	
NO.	TIME	TEMP.	
1	<input checked="" type="checkbox"/>	08:00 35°C	
2	<input checked="" type="checkbox"/>	12:00 25°C	
3	<input checked="" type="checkbox"/>	15:00 35°C	
☐ CANCEL			⬆ ⬇ ⬇ ⬆

Use "◀", "▶", "▼", "▲" to scroll and use "▼", "▲" to adjust the time and the temperature. Six periods and six temperatures can be set.

For example: Now time is 8:00 and temperature is 30°C. We set the PRESET TEMP as following table. The following page will appear:

01-01-2018		8:00	🏠 13°
☁	⬆ 08:00	ON	
💧	25 °C	☀	
🔋			

NO.	TIME	TEMPER
1	8:00	35°C
2	12:00	25°C
3	15:00	35°C
4	18:00	25°C
5	20:00	35°C
6	23:00	25°C

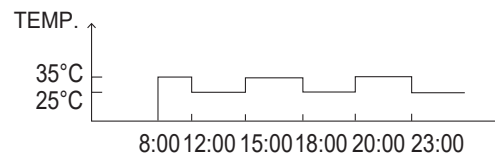

### INFORMATION

When the space operation mode is changed, the PRESET TEMP. is off automatically.

The PRESET TEMP. function can be used in the heat mode or cool mode. But if the operation mode is changed, the PRESET TEMP. function needs to be reset again.

The running preset temperature is valid when the unit is OFF. It will run according to the next preset temperature when the unit turn on again.

### 6.2.2 WEATHER TEMP. SET

- WEATHER TEMP. SET=WEATHER TEMPERATURE SET

- WEATHER TEMP.SET function is used to preset the desired water flow temperature depending on the outside air temperature. During the warmer weather the heating is reduced. To save energy, the weather temp.set can decrease the desired water flow temperature when the outdoor air temperature increased in heating mode.

Go to "☐" > "PRESET TEMPERATURE" > "WEATHER TEMP. SET". Press "↵".

The following page will appear:

PRESET TEMPERATURE		
PRESET TEMP.	WEATHER TEMP.SET	ECO MODE
ZONE1 C-MODE LOW TEMP.		OFF
ZONE1 H-MODE LOW TEMP.		OFF
ZONE2 C-MODE LOW TEMP.		OFF
ZONE2 H-MODE LOW TEMP.		OFF
ON/OFF		

### INFORMATION

• WEATHER TEMP. SET have four kinds of curves :1.the curve of the high temperature setting for heating,2.the curve of the low temperature setting for heating, 3.the curve of the high temperature setting for cooling ,4.the curve of the low temperature setting for cooling. It only uses the curve of the high temperature setting for heating, if the high temperature is set for heating.

It only uses the curve of the low temperature setting for heating, if the low temperature is set for heating.

It only uses the curve of the high temperature setting for cooling, if the high temperature is set for cooling.

It only uses the curve of the low temperature setting for cooling, if the low temperature is set for cooling.

• See "FOR SERVICEMAN"> "COOL MODE SETTING" and > "HEAT MODE SETTING" in "Installation and owner's manual".

• The desired temperature (T1S) can't be adjusted, when the temperature curve is set ON.

- If you want to use heat mode in zone 1 ,you select "ZONE1 H-MODE LOW TEMP". If you want to use cool mode in zone 1, you select "ZONE1 C-MODE LOW TEMP". If you select "ON", the following page will appear:

WEATHER TEMP. SET	
WEATHER TEMP. SET TYPE:	
1	2
3	4
5	6
7	8
9	
CONFIRM	

Use '◀', '▶' to scroll .Press "↵" to select.

PRESET TEMPERATURE		
PRESET TEMP.	WEATHER TEMP.SET	ECO MODE
ZONE1 C-MODE LOW TEMP		ON
ZONE1 H-MODE LOW TEMP		OFF
ZONE2 C-MODE LOW TEMP		OFF
ZONE2 H-MODE LOW TEMP		OFF
ON/OFF		

- If the weather TEMP.SET is activated, the desired temperature can not be adjusted on the interface.Press the "▼", "▲" to adjust the temperature on home page. The following page will appear:

01-01-2018	23:59	↑13°
Weather temp.set function is on. Do you want to turn off it?		
NO		YES
CONFIRM		

Move to "NO",press "↵" to come back to home page,move to "YES",press "↵" to reset the WEATHER TEMP. SET.

PRESET TEMPERATURE		
PRESET TEMP.	WEATHER TEMP.SET	ECO MODE
ZONE1 C-MODE LOW TEMP		OFF
ZONE1 H-MODE LOW TEMP		OFF
ZONE2 C-MODE LOW TEMP		OFF
ZONE2 H-MODE LOW TEMP		OFF
ON/OFF		

### 6.2.3 ECO MODE

ECO MODE is used to save energy. Go to "☰" > "PRESET TEMPERATURE" > "ECO MODE". Press "↵". The following page will appear:

PRESET TEMPERATURE		
PRESET TEMP.	WEATHER TEMP.SET	ECO MODE
CURRENT STATE		OFF
ECO TIMER		OFF
START		08:00
END		19:00
ON/OFF		

Press "⏻". The following page will appear:

ECO MODE SET	
ECO MODE SET TYPE:	
1	2
3	4
5	6
7	8
9	
CONFIRM	

Use "◀", "▶" to scroll. Press "↵" to select. The following page will appear:

PRESET TEMPERATURE		
PRESET TEMP.	WEATHER TEMP.SET	ECO MODE
CURRENT STATE		ON
ECO TIMER		OFF
START		08:00
END		19:00
ON/OFF		↕

Use "⏻" to turn ON or OFF, and use "▼", "▲" to scroll.

PRESET TEMPERATURE		
PRESET TEMP.	WEATHER TEMP.SET	ECO MODE
CURRENT STATE		OFF
ECO TIMER		ON
START		08:00
END		19:00
ADJUST		↕

When the cursor is on the "START" or on the "END", you can use "◀", "▶", "▼", "▲" to scroll and use "▼", "▲" to adjust the time.

### INFORMATION

- ECO MODE SET have two kinds of curves :1.the curve of the high temperature setting for heating, 2.the curve of the low temperature setting for heating, It only uses the curve of the high temperature setting for heating, if the high temperature is set for heating.  
It only uses the curve of the low temperature setting for heating, if the low temperature is set for heating.
- See "FOR SERVICEMAN">"HEAT MODE SETTING" in "Installation and owner's manual".
- The desired temperature (T1S) can't be adjusted, when the ECO mode is ON.
- You can select the low or high temperature setting for heating to see the "Table 1~2".
- If ECO MODE is ON and ECO TIMER is OFF, the unit runs ECO mode all the time.
- If ECO MODE is ON and ECO TIMER is ON, the unit runs ECO mode according to the start time and end time.

## 6.3 Domestic Hot Water(DHW)

DHW mode typically consists of the following :

- 1) DISINFECT
- 2) FAST DHW
- 3) TANK HEATER
- 4) DHW PUMP

### 6.3.1 Disinfect

The DISINFECT function is used to kill the legionella. In the disinfect function, the tank temperature will be reached 65~70°C forcibly. The disinfect temperature is set in FOR SERVICEMAN. See "FOR SERVICEMAN" > "DHW MODE" > "DISINFECT" in "Installation and owner's manual (M-thermal split indoor unit)".

Go to "☰" > "DOMESTIC HOT WATER" > "DISINFECT". Press "↵". The following page will appear:

DOMESTIC HOT WATER (DHW)			
DIS-INFECT	FAST DHW	TANK HEATER	DHW PUMP
CURRENT STATE			ON
OPERATE DAY			FRI
START			23:00
ON/OFF			↕



DOMESTIC HOT WATER (DHW)			
DIS-INFECT	FAST DHW	TANK HEATER	DHW PUMP
CURRENT STATE			OFF
OPERATE DAY			FRI
START			23:00
ON/OFF			↕

Use "◀", "▶", "▼", "▲" to scroll and use "▼", "▲" to adjust the parameters when setting "OPERATE DAY" and "START". If the OPERATE DAY is set FRIDAY and the START is set 23:00, the disinfect function will be activated on 23:00 Friday. If the disinfect function is running, the following page will appear:

01-01-2018	23:59	13°
 23.5 °C	 ON	 38 °C

### 6.3.2 Fast DHW

The FAST DHW function is used to force the system to operate in DHW mode.

The heat pump and the booster heater or addition heater will operate for DHW mode together, and the DHW desired temperature will be changed to 60 C.

Go to [Menu] > DOMESTIC HOT WATER >FAST DHW. Press "Enter":

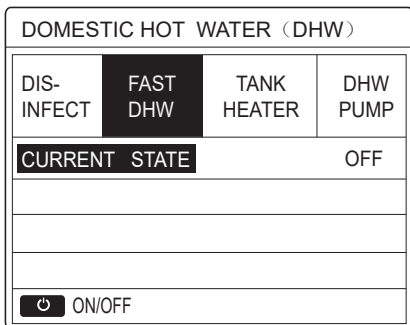
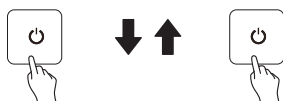
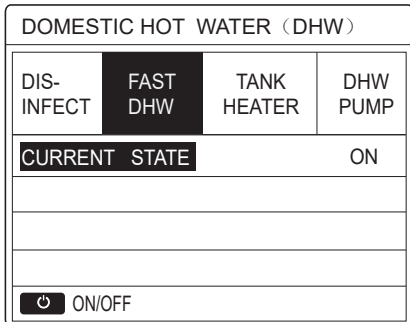

Use "Power" key to select ON or "OFF".

#### INFORMATION

If CURRENT STATE is OFF, the FAST DHW is invalid, and if CURRENT STATE is ON, the FAST DHW function is effective. The FAST DHW function is once effective.

### 6.3.3 TANK HEATER

The tank heater function is used to force the tank heater to heat the water in tank. In the same situation, the cooling or heating is required and the heat pump system is operating for cooling or heating, however there still is a demand for the hot water.

Also, even if the heat pump system fails, TANK HEATER can be used to heat water in tank.

Go to [Menu] > "DOMESTIC HOT WATER" > "TANK HEATER". Press "Enter".

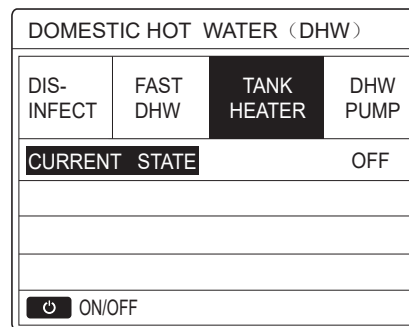
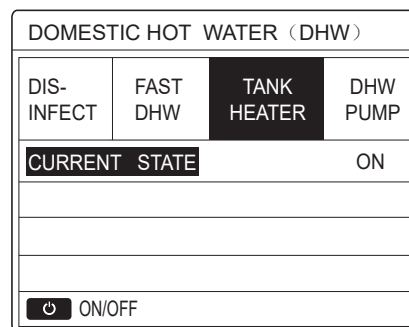

Use "Power" key to select ON or OFF. Use "Exit" key to exit.

If TANK HEATER is effect, the following page will appear:

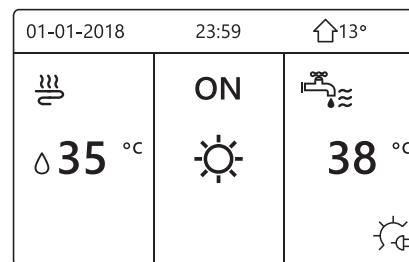

#### INFORMATION

If CURRENT STATE is OFF, TANK HEATER is invalid. If the T5(sensor of tank) is fault ,tank heater can't work.

### 6.3.4 DHW Pump

The DHW PUMP function is used to return water of the water net. Go to [Menu] > "DOMESTIC HOT WATER" > "DHW PUMP". Press "Enter". The following page will appear:

DOMESTIC HOT WATER (DHW) 1/2			
DIS-INFECT	FAST DHW	TANK HEATER	DHW PUMP
NO.	START	NO.	START
T1 <input type="checkbox"/>	00:00	T4 <input type="checkbox"/>	00:00
T2 <input type="checkbox"/>	00:00	T5 <input type="checkbox"/>	00:00
T3 <input type="checkbox"/>	00:00	T6 <input type="checkbox"/>	00:00

DOMESTIC HOT WATER (DHW) 2/2			
DIS-INFECT	FAST DHW	TANK HEATER	DHW PUMP
NO.	START	NO.	START
T7 <input type="checkbox"/>	00:00	T10 <input type="checkbox"/>	00:00
T8 <input type="checkbox"/>	00:00	T11 <input type="checkbox"/>	00:00
T9 <input type="checkbox"/>	00:00	T12 <input type="checkbox"/>	00:00

Move to "■", press "↵" to select or unselect. (  the timer is selected.  the timer is unselected.)

DOMESTIC HOT WATER (DHW) 1/2			
DIS-INFECT	FAST DHW	TANK HEATER	DHW PUMP
NO.	START	NO.	START
T1 <input checked="" type="checkbox"/>	00:00	T4 <input type="checkbox"/>	00:00
T2 <input type="checkbox"/>	00:00	T5 <input type="checkbox"/>	00:00
T3 <input type="checkbox"/>	00:00	T6 <input type="checkbox"/>	00:00

Use "◀", "▶", "▼", "▲" to scroll and use "▼", "▲" to adjust the parameters.

For example: you have set the parameter about the DHW PUMP (See "FOR SERVICEMAN" > "DHW MODE SETTING" on "Installation and owner's manual"). PUMP RUNNING TIME is 30 minutes.

Set as follows:

NO.	START
1	6:00
2	7:00
3	8:00
4	9:00

The PUMP will run as follows:

PUMP

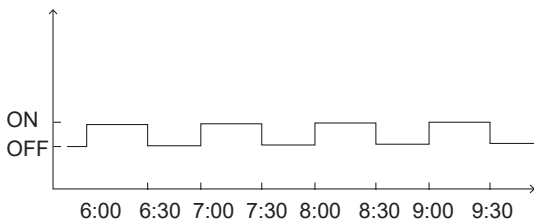

## 6.4 Schedule

SCHEDULE menu contents as follows:

- 1) TIMER
- 2) WEEKLY SCHEDULE
- 3) SCHEDULE CHECK
- 4) CANCEL TIMER

### 6.4.1 Timer

If the weekly schedule function is on, the timer is off, the later setting is effective. If the Timer is activated, ⌚ is displayed on home page.

SCHEDULE 1/2				
TIMER	WEEKLY SCHEDULE	SCHEDULE CHECK	CANCEL TIMER	
NO.	START	END	MODE	TEMP
1 <input type="checkbox"/>	00:00	00:00	HEAT	0°C
2 <input type="checkbox"/>	00:00	00:00	HEAT	0°C
3 <input type="checkbox"/>	00:00	00:00	HEAT	0°C

SCHEDULE 2/2				
TIMER	WEEKLY SCHEDULE	SCHEDULE CHECK	CANCEL TIMER	
NO.	START	END	MODE	TEMP
4 <input type="checkbox"/>	00:00	00:00	HEAT	0°C
5 <input type="checkbox"/>	00:00	00:00	HEAT	0°C
6 <input type="checkbox"/>	00:00	00:00	HEAT	0°C

- Use "◀", "▶", "▼", "▲" to scroll and use "▼", "▲" to adjust the time, the mode and the temperature.

Move to "■", press "↵" to select or unselect. (  the timer is selected.  the timer is unselected.) six timers can be set.

If you want to cancel the TIMER, you move the cursor to "■", press "↵", the  become , the timer is invalid.

If you set the start time later than the end time or the temperature out of range of the mode. The following page will appear:

SCHEDULE			
TIMER	WEEKLY SCHEDULE	SCHEDULE CHECK	CANCEL TIMER
Timer1 is useless.			
Please check the timer setting and temperature setting.			
CONFIRM			

## Example:

Six timers is set as following:

NO.	START	END	MODE	TEMP
T1	1: 00	3: 00	DHW	50°C
T2	7: 00	9: 00	HEAT	28°C
T3	11: 30	13: 00	COOL	20°C
T4	14: 00	16: 00	HEAT	28°C
T5	15: 00	19: 00	COOL	20°C
T6	18: 00	23: 30	DHW	50°C

The unit will run as following:

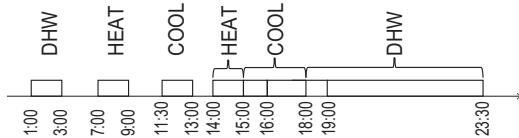

The operation of the controller at the following time:

TIME	The operatin of the controller
1: 00	DHW mode is turned ON
3: 00	DHW mode is turned OFF
7: 00	HEAT MODE is turned ON
9: 00	HEAT MODE is turned OFF
11: 30	COOL MODE is turned ON
13: 00	COOL MODE is turned OFF
14: 00	HEAT MODE is turned ON
15: 00	COOL MODE is turned ON and HEAT MODE is turned OFF
18: 00	DHW MODE is turned ON and COOL MODE is turned OFF
23: 30	DHW mode is turned OFF

### INFORMATION

If the start time is same to the end time in one timer, the timer is invalid.

### 6.4.2 Weekly schedule

If the timer function is on and the weekly schedule is off, the later setting is effective.If WEEKLY SCHEDULE is activated, **7** is displayed on the home page.

Go to " " > "SCHEDULE" >"WEEKLY SCHEDULE". Press " ". The following page will appear:

SCHEDULE			
TIMER	WEEKLY SCHEDULE	SCHEDULE CHECK	CANCEL TIMER
MON.	TUE.	WED.	THU. FRI. SAT. SUN.
<input checked="" type="checkbox"/>	<input type="checkbox"/>	<input type="checkbox"/>	<input type="checkbox"/>
ENTER		CANCEL	
MON SELECT			

First select the days of the week you wish to schedule. Use " ", " "to scroll, press " " to select or unselect the day.

" **MON** " means that the day is selected,"MON" means that the day is unselected.

### INFORMATION

We must set two days at least when we want to enable WEEKLY SCHEDULE function.

SCHEDULE			
TIMER	WEEKLY SCHEDULE	SCHEDULE CHECK	CANCEL TIMER
MON.	TUE.	WED.	THU. FRI. SAT. SUN.
<input type="checkbox"/>	<input type="checkbox"/>	<input type="checkbox"/>	<input checked="" type="checkbox"/>
ENTER		CANCEL	
MON SELECT			

Use " "or " " to SET, press"ENTER".The Monday to Friday are selected to be scheduled and they have the same schedule.

The following pages will appear:

SCHEDULE				1/2	
TIMER	WEEKLY SCHEDULE	SCHEDULE CHECK	CANCEL TIMER		
NO.	START	END	MODE	TEMP	
<b>1</b>	<input type="checkbox"/>	00:00	00:00	HEAT	0°C
2	<input type="checkbox"/>	00:00	00:00	HEAT	0°C
3	<input type="checkbox"/>	00:00	00:00	HEAT	0°C

SCHEDULE				2/2	
TIMER	WEEKLY SCHEDULE	SCHEDULE CHECK	CANCEL TIMER		
NO.	START	END	MODE	TEMP	
<b>4</b>	<input type="checkbox"/>	00:00	00:00	HEAT	0°C
5	<input type="checkbox"/>	00:00	00:00	HEAT	0°C
6	<input type="checkbox"/>	00:00	00:00	HEAT	0°C

Use " ", " ", " ", " " to scroll and adjust the time ,the mode and the temperature. Timers can be set, including start time and end time,mode and temperature. The mode includes heat mode, cool mode and DHW mode.

The setting method refer to timer setting. The end time must be later than the start time.Otherwise this will show that Timer is useless.



### 6.4.3 Schedule check

schedule check can only check the weekly schedule.

Go to " " > "SCHEDULE" > "SCHEDULE' CHECK". Press " ". The following page will appear:

SCHEDULE			
TIMER	WEEKLY SCHEDULE	SCHEDULE CHECK	CANCEL TIMER
WEEKLY SCHEDULE CHECK			
ENTER			

WEEKLY SCHEDULE CHECK					
DAY	NO	MODE	SET	START	END
MON <input type="checkbox"/>	T1	<input type="checkbox"/> HEAT	0°C	00:00	00:00
	T2	<input type="checkbox"/> HEAT	0°C	00:00	00:00
	T3	<input type="checkbox"/> HEAT	0°C	00:00	00:00
	T4	<input type="checkbox"/> HEAT	0°C	00:00	00:00
	T5	<input type="checkbox"/> HEAT	0°C	00:00	00:00
	T6	<input type="checkbox"/> HEAT	0°C	00:00	00:00

Press " ", " ", the timer from Monday to Sunday will appear:

### 6.4.4 CANCEL TIMER

Go to " " > "SCHEDULE" > "CANCEL TIMER". Press " ". The following page will appear:

SCHEDULE			
TIMER	WEEKLY SCHEDULE	SCHEDULE CHECK	CANCEL TIMER
Do you want to cancel the timer and weekly schedule?			
NO		YES	
ENTER			

Use " ", " ", " ", " " to move to "YES", press " " to cancel timer. If you want to exit CANCEL TIMER, press "BACK".

If TIMER or WEEKLY SCHEDULE is activated, timer icon " " or weekly schedule icon " " will display on the home page.

01-01-2018	23:59		13°
	ON		38 °C
23.5 °C			

If TIMER or WEEKLY SCHEDULE is canceled, icon " " or " " will disappear on the home page.

01-01-2018	23:59	13°
	ON	
23.5 °C		38 °C

### INFORMATION

You have to reset TIMER/WEEKLY SCHEDULE, if you change the WATER FLOW TEMP. to the ROOM TEMP. or you change the ROOM TEMP. to the WATER FLOW TEMP. The TIMER or WEEKLY SCHEDULE is invalid, if ROOM THERMOSTAT is activated.

### INFORMATION

- The ECO has the highest priority, the TIMER or WEEKLY SCHEDULE has the second priority and the PRESET TEMP. or WEATHER TEMP. SET has the lowest priority.
- The PRESET TEMP. or WEATHER TEMP. SET becomes invalid, when we set the ECO valid. We must reset the PRESET TEMP. or WEATHER TEMP. SET when we set the ECO invalid.
- TIMER or WEEKLY SCHEDULE is invalid when ECO is valid. TIMER or WEEKLY SCHEDULE is activated when the ECO is not running.
- TIMER and WEEKLY SCHEDULE are on the same priority. The later setting function is valid. The PRESET TEMP. becomes invalid when TIMER or WEEKLY SCHEDULE is valid. The WEATHER TEMP. SET is not affected by the setting of TIMER or WEEKLY SCHEDULE.
- PRSET TEMP. and WATHER TEMP.SET are on the same priority. The later setting function is valid.

### INFORMATION

All about the time set items(PRESET TEMP. , ECO DISINFECT, DHW PUMP, TIMER, WEEKLY SCHEDULE, SILENCE MODE , HOLIDAY HOME), the ON/OFF of the corresponding function can be activated from the start time to the end time.

## 6.5 Options

OPTIONS menu contents as following:

- 1) SILENT MODE
- 2) HOLIDAY AWAY
- 3) HOLIDAY HOME
- 4) BACKUP HEATER

### 6.5.1 Silent Mode

The SILENT MODE is used to decrease the sound of the unit. However, it also decreases the heating/cooling capacity of the system. There are two silent mode levels. level2 is more silent than level1, and the heating or cooling capacity is also more decreasing.

There are two methods to use the silent mode:

- 1) silent mode in all time;
- 2) silent mode in timer.

- Go to the home page to check if silent mode is activated. If the silent mode is activated, "☾\*" will be displayed on the home page.

- Go to "☰" > "OPTIONS" > "SILENT MODE". Press "↵". The following page will appear:

OPTIONS				1/2
SILENT MODE	HOLIDAY AWAY	HOLIDAY HOME	BACKUP HEATER	
CURRENT STATE				OFF
SILENT LEVEL				LEVEL 1
TIMER1 START				12:00
TIMER1 END				15:00
ON/OFF				↔

Use "⏻" to select ON or OFF.

Description:

If CURRENT STATE is OFF, SILENT MODE is invalid.

When you select SILENT LEVEL, and press "↵" or "▶". The following page will appear:

OPTIONS				1/2
SILENT MODE	HOLIDAY AWAY	HOLIDAY HOME	BACKUP HEATER	
CURRENT STATE				ON
SILENT LEVEL				LEVEL 1
TIMER1 START				12:00
TIMER1 END				15:00
ADJUST				↔

LEVEL 1

OPTIONS				1/2
SILENT MODE	HOLIDAY AWAY	HOLIDAY HOME	BACKUP HEATER	
CURRENT STATE				ON
SILENT LEVEL				LEVEL 2
TIMER1 START				12:00
TIMER1 END				15:00
ADJUST				↔

LEVEL 2

You can use "▼", "▲" to select level 1 or level 2. Press "↵".

If the silent TIMER is selected, Press "↵" to enter, the following page will appear.

OPTIONS				2/2
SILENT MODE	HOLIDAY AWAY	HOLIDAY HOME	BACKUP HEATER	
TIMER1				OFF
TIMER2 START				22:00
TIMER2 END				07:00
TIMER2				OFF
ADJUST				↔

There are two timers for setting. Move to "■", press "↵" to select or unselect.

If the two time are both unselected, the silent mode will operate in all time. Otherwise, it will operate according as the time.

### 6.5.2 Holiday Away

- If the holiday away mode is activated, ☽ will display on the home page.

The holiday away function is used to prevent frozen in the winter during the outside holiday, and return the unit before the end of the holiday.

Go to "☰" > "OPTIONS" > "HOLIDAY AWAY". Press "↵". The following page will appear:

OPTIONS				1/2
SILENT MODE	HOLIDAY AWAY	HOLIDAY HOME	BACKUP HEATER	
CURRENT STATE				OFF
DHW MODE				ON
DISINFECT				ON
HEAT MODE				ON
ON/OFF				↔

OPTIONS				2/2
SILENT MODE	HOLIDAY AWAY	HOLIDAY HOME	BACKUP HEATER	
FROM				00-00-2000
UNTIL				00-00-2000
ADJUST				↔

Usage example: You go away during the winter. The current date is 2018-01-31, two days later is 2018-02-02, it is the beginning date of the holiday.

- If you are in the following situation:
- In 2 days, you go away for 2 weeks during the winter.
- You want to save energy, but prevent your house from freezing.

Then you can do the following:

- 1) Configure the holiday away the following settings:
  - 2) Activate the holiday mode.
- Go to " " > "OPTIONS" > "HOLIDAY AWAY". Press "↵". Use " " to select "OFF" or "ON" and use "◀", "▶", "▼", "▲" to scroll and adjust.

Setting	Value
Holiday away	ON
From	2 February 2018
Until	16 February 2018
Operation mode	Heating
disinfect	ON

### **i** INFORMATION

- If DHW mode in holiday away mode is ON, The disinfect set by user is invalid.
- If holiday away mode is ON, The timer and weekly schedule are invalid except exit.
- If the CURRENT STATE is OFF, the HOLIDAY AWAY is OFF.
- If the CURRENT STATE is ON, the HOLIDAY AWAY is ON.
- Disinfecting the unit on 23:00 of the last day if disinfect is ON.
- When in holiday away mode, the climate related curves previously set is invalid, and the curves will automatically take effect after the holiday away mode is ends.
- The preset temperature is invalid when in holiday away mode, but the preset value still display on the main page.

### 6.5.3 Holiday Home

The holiday home function is used to deviate from the normal schedules without having to change them during the holiday at home.

- During your holiday, you can use the holiday mode to deviate from your normal schedules without having to change them.

Period	Then...
Before and after your holiday	Your normal schedules will be used.
During your holiday	The configured holiday settings will be used.

If the holiday home mode is activated,  will display on the home page. Go to " " > "OPTIONS" > "HOLIDAY HOME". Press "↵". The following page will appear:

OPTIONS			
SILENT MODE	HOLIDAY AWAY	HOLIDAY HOME	BACKUP HEATER
CURRENT STATE			OFF
FROM			00-00-2000
UNTIL			00-00-2000
TIMER			ENTER
ON/OFF			▶

Use " " to select "OFF" or "ON" and use "◀", "▶", "▼", "▲" to scroll and adjust.

If the CURRENT STATE is OFF, the HOLIDAY HOME is OFF.

If the CURRENT STATE is ON, the HOLIDAY HOME is ON.

Use "▼", "▲" to adjust the date.

- Before and after your holiday, your normal schedule will be used.
- During your holiday, you save energy and prevent your house from freezing.

### **i** INFORMATION

You have to exit Holiday away or Holiday home, if you change the operation mode of the unit.

### 6.5.4 Backup Heater

- The BACKUP HEATER function is used to force the backup heater. Go to " " > "OPTIONS" > "BACKUP HEATER". Press "↵". If IBH and AHS is set invalid by DIP switch on the main control board of hydraulic module, The following page will appear:

OPTIONS			
SILENT MODE	HOLIDAY AWAY	HOLIDAY HOME	BACKUP HEATER
▶			

IBH=Indoor unit backup heater.  
AHS=Additional heating source.

- If IBH and AHS is set valid by DIP switch on the main control board of hydraulic module, The following page will appear:

OPTIONS			
SILENT MODE	HOLIDAY AWAY	HOLIDAY HOME	BACKUP HEATER
BACKUP HEATER			ON
ON/OFF			▶

Use "  " to select "OFF" or "ON" .

### INFORMATION

- If the operation mode is auto mode in space heating or cooling side, the backup heater function can not be selected.
- The BACKUP HEATER function is invalid when only ROOM HEAT MODE enabled.

## 6.6 Child Lock

The CHILD Lock function is used to prevent children error operation. The mode setting and temperature adjusting can be locked or unlocked by using CHILD LOCK function. Go to "  " > "CHILD LOCK". The page is displayed:

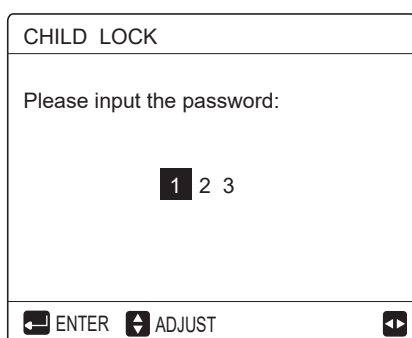

Input the current password, the following page will appear:

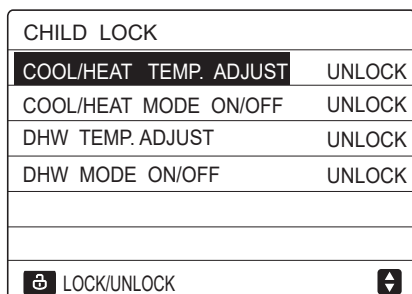

Use "▼", "▲" to scroll and "  " to select LOCK or UNLOCK.

The cool/heat temperature can't be adjusted when the COOL/HEAT TEMP. ADJUST is locked. If you want to adjust the cool/heat temperature when cool/heat temperature is locked, the following page will appear:

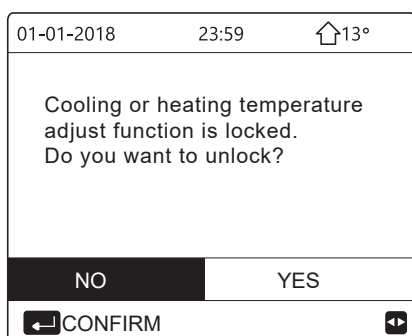

The cool/heat mode can't turn on or off when the COOL/HEAT MODE ON/OFF is locked. If you want to turn on or off the cool/heat mode when COOL/HEAT MODE ON/OFF is locked, the following page will appear:

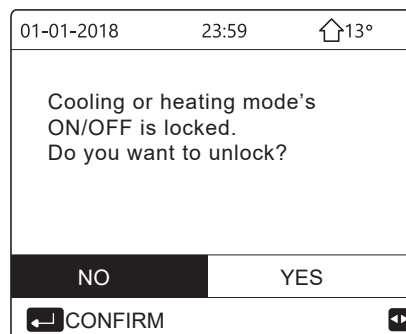

The DHW temperature can't be adjusted when the DHW TEMP. ADJUST is locked. If you want to adjust the DHW temperature when DHW TEMP. ADJUST is locked, the following page will appear:

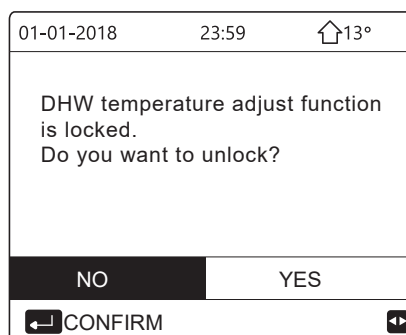

The DHW mode can't turn on or off when the DHW MODE ON/OFF is locked. If you want to turn on or off the DHW mode when DHW MODE ON/OFF is locked, the following page will appear:

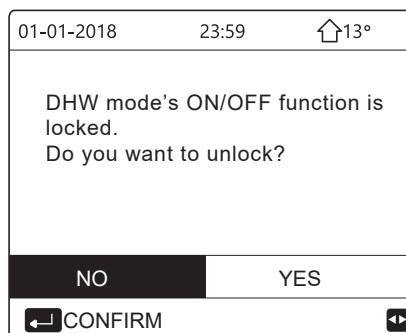



## 6.7 Service information

### 6.7.1 About service information

Service information menu contents as following:

- 1) SERVICE CALL
- 2) ERROR CODE
- 3) PARAMETER
- 4) DISPLAY

### 6.7.2 How to go to service information menu

- Go to "  " > "SERVICE INFORMATION". Press "  ". The following page will appear:

The service call can show the service phone or mobile number. The installer can input the phone number. See "FOR SERVICEMAN".

SERVICE INFORMATION			
SERVICE CALL	ERROR CODE	PARAMETER	DISPLAY
PHONE NO.	*****		
MOBILE NO.	*****		

Error code is used to show when the fault or protection happens and show the mean of the error code.

SERVICE INFORMATION			
SERVICE CALL	ERROR CODE	PARAMETER	DISPLAY
E2	#00	14:10	01-01-2018
E2	#00	14:00	01-01-2018
E2	#00	13:50	01-01-2018
E2	#00	13:20	01-01-2018
← ENTER →			

Press ← the page will appear:

SERVICE INFORMATION 1/2			
SERVICE CALL	ERROR CODE	PARAMETER	DISPLAY
E2	#00	14:10	01-01-2018
E2	#00	14:00	01-01-2018
E2	#00	13:50	01-01-2018
E2	#00	13:20	01-01-2018
← ENTER →			

press ← to show the mean of the error code :

01-01-2018	23:59	🏠 13°
E2 communication fault between controller and indoor unit		
Please contact your dealer.		
← CONFIRM		#00

### **i** INFORMATION

A total of eight fault codes can be recorded.

The parameter function is used to display the main parameter, there are two pages to show the parameter:

SERVICE INFORMATION 1/2			
SERVICE CALL	ERROR CODE	PARAMETER	DISPLAY
		ROOM SET TEMP.	26°C
		MAIN SET TEMP.	55°C
		TANK SET TEMP.	55°C
		ROOM ACTUAL TEMP.	24°C

SERVICE INFORMATION 2/2			
SERVICE CALL	ERROR CODE	PARAMETER	DISPLAY
		MAIN ACTUAL TEMP.	26°C
		TANK ACTUAL TEMP.	55°C
		SMART GRID RUNNING TIME	0 Hrs

The DISPLAY function is used to set the interface:

SERVICE INFORMATION 1/2			
SERVICE CALL	ERROR CODE	PARAMETER	DISPLAY
		TIME	12:30
		DATE	08-08-2018
		LANGUAGE	EN
		BACKLIGHT	ON
← ENTER →			

SERVICE INFORMATION 2/2			
SERVICE CALL	ERROR CODE	PARAMETER	DISPLAY
		BUZZER	ON
		SCREEN LOCK TIME	120SEC
		SMART GRID RUNNING TIME	2 Hrs
⏻ ON/OFF ↕			

Use "←" to enter and use "◀", "▶", "▼", "▲" to scroll.

## 6.8 Operation Parameter

This menu is for installer or service engineer reviewing the operation parameter.

- At home page, go to "☰" > "OPERATION PARAMETER".
- Press "←". There are nine pages for the operating parameter as following. Use "▼", "▲" to scroll.
- Press "▶" and "◀" to check slave units' operation parameter in cascade system. The address code in the upper right corner will change from "#00" to "#01", "#02" etc. accordingly.

OPERATION PARAMETER	#00
ONLINE UNITS NUMBER	1
OPERATE MODE	COOL
SV1 STATE	ON
SV2 STATE	OFF
SV3 STATE	OFF
PUMP_I	ON
ADDRESS	1/9

OPERATION PARAMETER	#00
PUMP_O	OFF
PUMP_C	OFF
PUMP_S	OFF
PUMP_D	OFF
PIPE BACKUP HEATER	OFF
TANK BACKUP HEATER	ON
ADDRESS	2/9

OPERATION PARAMETER	#00
GAS BOILER	OFF
T1 LEAVING WATER TEMP.	35°C
WATER FLOW	1.72m <sup>3</sup> /h
HEAT PUMP CAPACTIY	11.52kW
POWER CONSUM	1000kWh
Ta ROOM TEMP.	25°C
ADDRESS	3/9

OPERATION PARAMETER	#00
T5 WATER TANK TEMP.	53°C
Tw2 CIRCUIT2 WATER TEMP.	35°C
TIS' C1 CLI. CURVE TEMP.	35°C
TIS2' C2 CLI. CURVE TEMP.	35°C
TW_O PLATE W-OUTLET TEMP.	35°C
TW_I PLATE W-INLET TEMP.	30°C
ADDRESS	4/9

OPERATION PARAMETER	#00
Tbt1 BUFFERTANK_UP TEMP.	35°C
Tbt2 BUFFERTANK_LOW TEMP.	35°C
Tsolar	25°C
IDU SOFTWARE	01-09-2019V01
ADDRESS	5/9

OPERATION PARAMETER	#00-
ODU MODEL	6kW
COMP.CURRENT	12A
COMP.FREQUENCY	24Hz
COMP.RUN TIME	54 MIN
COMP.TOTAL RUN TIME	1000Hrs
EXPANSION VALVE	200P
ADDRESS	6/9

OPERATION PARAMETER	#00
FAN SPEED	600R/MIN
IDU TARGET FREQUENCY	46Hz
FREQUENCY LIMITED TYPE	5
SUPPLY VOLTAGE	230V
DC GENERATRIX VOLTAGE	420V
DC GENERATRIX CURRENT	18A
ADDRESS	7/9

OPERATION PARAMETER	#00
TW_O PLATE W-OUTLET TEMP.	35°C
TW_I PLATE W-INLET TEMP.	30°C
T2 PLATE F-OUT TEMP.	35°C
T2B PLATE F-IN TEMP.	35°C
Th COMP. SUCTION TEMP.	5°C
Tp COMP. DISCHARGE TEMP.	75°C
ADDRESS	8/9

OPERATION PARAMETER	#00
T3 OUTDOOR EXCHANGE TEMP.	5°C
T4 OUTDOOR AIR TEMP.	5°C
TF MODULE TEMP.	55°C
P1 COMP. PRESSURE	2300kPa
ODU SOFTWARE	01-09-2018V01
HMI SOFTWARE	01-09-2018V01
ADDRESS	9/9

### INFORMATION

The power consumption parameter is optional. If some parameter is not be activated in the system, the parameter will show "--". The heat pump capacity is for reference only, not used to judge the ability of the unit. The accuracy of sensor is ±1°C. The flow rates parameters are calculated according to the pump running parameters, the deviation is different at different flow rates, the maximum of deviation is 15%. The flow parameters are calculated according to the electrical parameters of the pump operation. The operating voltage is different and the deviation is different. The display value is 0 when the voltage is less than 198V.

## 6.9 For Serviceman

### 6.9.1 About For Serviceman

FOR SERVICEMAN is used for installer and service engineer.

- Setting the function of equipment.
- Setting the parameters.

### 6.9.2 How To Go To For Serviceman

Go to " " > "FOR SERVICEMAN". Press " ← " .

FOR SERVICEMAN	
Please input password:	
2 3 4	
ENTER	ADJUST

- The FOR SERVICEMAN is used for installer or service engineer. It is NOT intended the home owner alters setting with this menu.
- It is for this reason password protection is required to prevent unauthorised access to the service settings.
- The password is 234.

### 6.9.3 How To Exit For SERVICEMAN

If you have set all the parameter.  
Press "↵", the following page will appear :

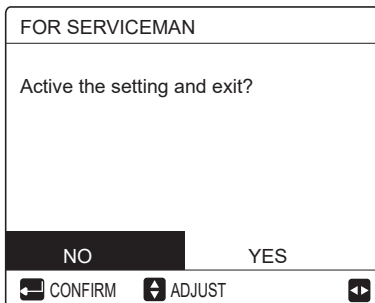

Select "YES" and press "↵" to exit the FOR SERVICEMAN.  
After exiting the FOR SERVICEMAN, the unit will be turned off.

## 6.10 Network Configuration Guidelines

- The wired controller realizes intelligent control with a built-in module, which receives control signal from the APP.
- Before connecting the WLAN, please check for it if the router in your environment is active and make sure that the wired controller is well-connected to the wireless signal.
- During the Wireless distribution process, the LCD icon "📶" flashes to indicate that the network is being deployed. After the process is completed, the icon "📶" will be constantly on.

### 6.10.1 Wired Controller Setting

The wired controller settings include AP MODE and RESTORE WLAN SETTING.

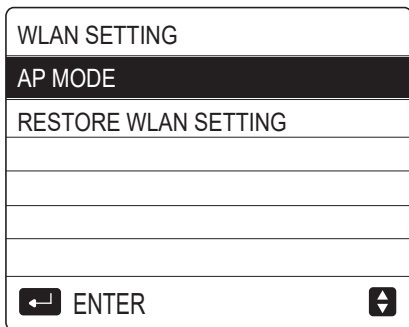

- Activate the WLAN by interface. Go to "☰" > "WLAN SETTING" > "AP MODE".  
Press "↵", the following page will appear:

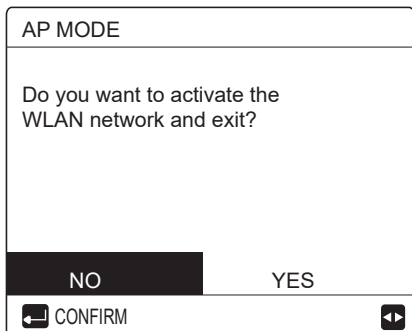

Use "◀", "▶" to move to "YES", press "↵" to select AP mode.  
Select AP Mode correspondingly on the mobile device and continue the follow-up settings according to the APP prompts.

**⚠ CAUTION**

After enter Ap mode, if it's not connected with mobile phone, the LCD icon "📶" will flash 10 minutes then disappear.  
If it's connected with the mobile phone, the icon "📶" will be constantly display.

- Restore WLAN setting by interface. Go to "☰" > "WLAN SETTING" > "RESTORE WLAN SETTING".  
Press "↵", the following page will appear:

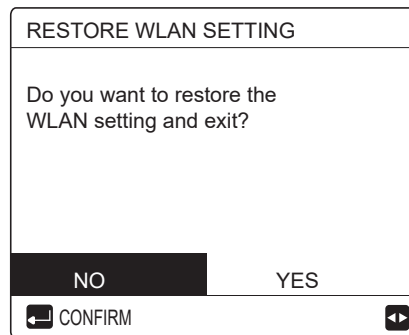

Use "◀", "▶" to move to "YES", press "↵" to restore WLAN setting. Complete the above operation and wireless configuration is reset.

- AP Mode connecting WLAN:

### 6.11 SN VIEW

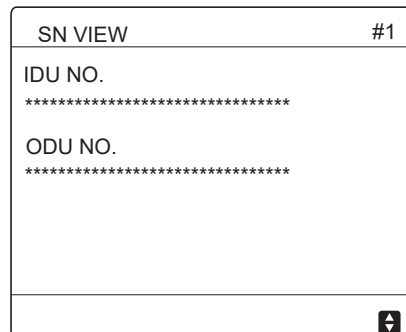
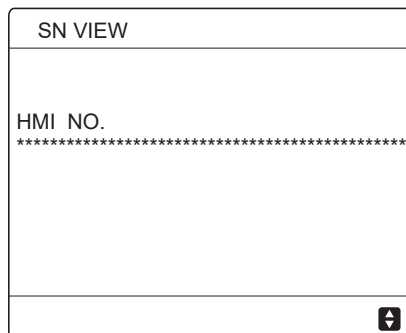

# 7 MENU STRUCTURE : OVERVIEW

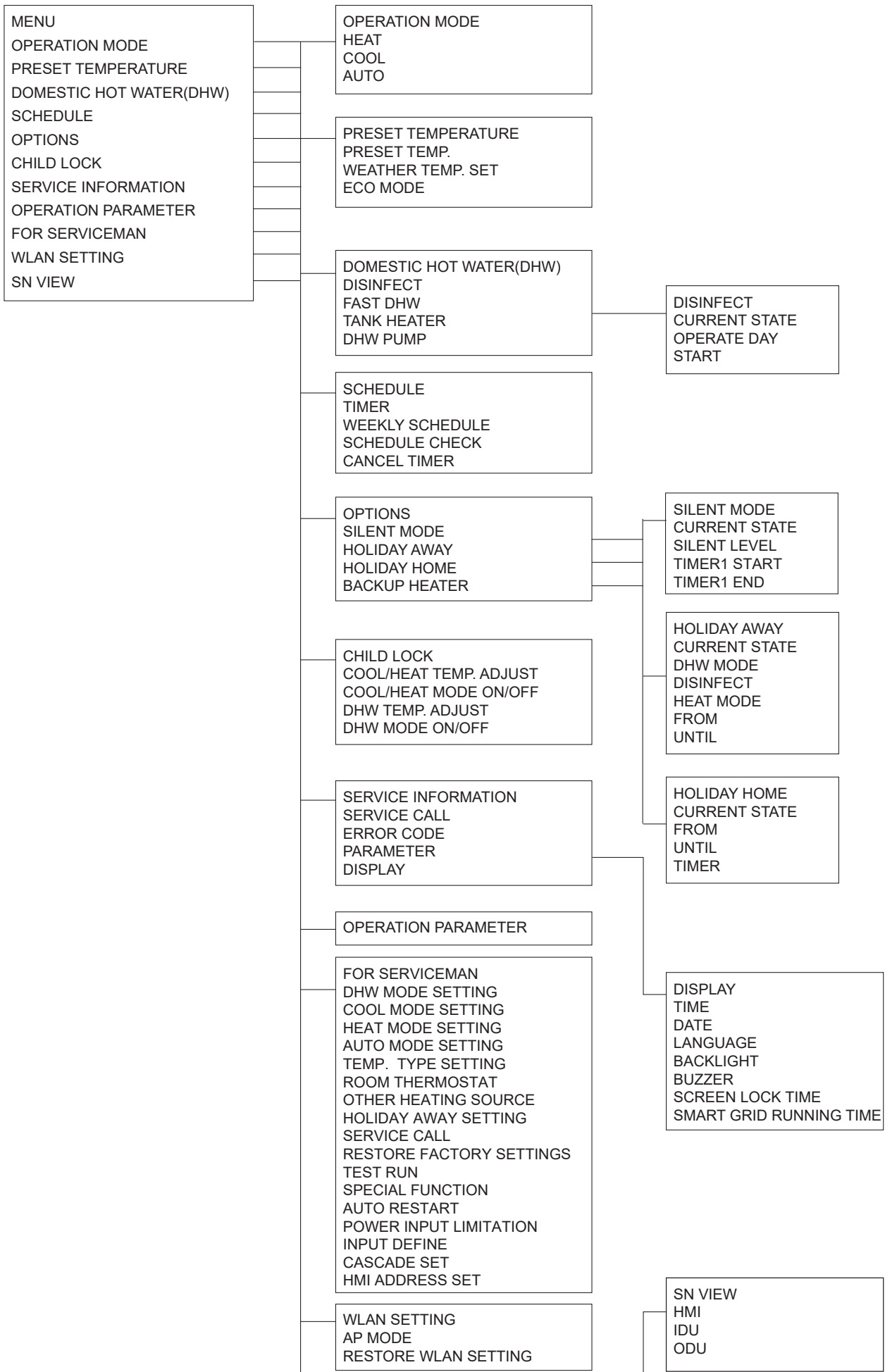



FOR SERVICEMAN  
 1 DHW MODE SETTING  
 2 COOL MODE SETTING  
 3 HEAT MODE SETTING  
 4 AUTO MODE SETTING  
 5 TEMP. TYPE SETTING  
 6 ROOM THERMOSTAT  
 7 OTHER HEATING SOURCE  
 8 HOLIDAY AWAY SETTING  
 9 SERVICE CALL  
 10 RESTORE FACTORY SETTINGS  
 11 TEST RUN  
 12 SPECIAL FUNCTION  
 13 AUTO RESTART  
 14 POWER INPUT LIMITATION  
 15 INPUT DEFINE  
 16 CASCADE SET  
 17 HMI ADDRESS SET

2 COOL MODE SETTING  
 2.1 COOL MODE  
 2.2 t\_T4\_FRESH\_C  
 2.3 T4CMAX  
 2.4 T4CMIN  
 2.5 dT1SC  
 2.6 dTSC  
 2.7 t\_INTERVAL\_C  
 2.8 T1SetC1  
 2.9 T1SetC2  
 2.10 T4C1  
 2.11 T4C2  
 2.12 ZONE1 C-EMISSION  
 2.13 ZONE2 C-EMISSION

4 AUTO MODE SETTING  
 4.1 T4AUTOCMIN  
 4.2 T4AUTOHMAX

5 TEMP. TYPE SETTING  
 5.1 WATER FLOW TEMP.  
 5.2 ROOM TEMP.  
 5.3 DOUBLE ZONE

6 ROOM THERMOSTAT  
 6.1 ROOM THERMOSTAT

7 OTHER HEATING SOURCE  
 7.1 dT1\_IBH\_ON  
 7.2 t\_IBH\_DELAY  
 7.3 T4\_IBH\_ON  
 7.4 dT1\_AHS\_ON  
 7.5 t\_AHS\_DELAY  
 7.6 T4\_AHS\_ON  
 7.7 IBH LOCATE  
 7.8 P\_IBH1  
 7.9 P\_IBH2  
 7.10 P\_TBH

8 HOLIDAY AWAY SETTING  
 8.1 T1S\_H.A.\_H  
 8.2 T5S\_H.A.\_DHW

9 SERVICE CALL  
 PHONE NO.  
 MOBILE NO.

10 RESTORE FACTORY SETTINGS

11 TEST RUN

12 SPECIAL FUNCTION

13 AUTO RESTART  
 13.1 COOL/HEAT MODE  
 13.2 DHW MODE

14 POWER INPUT LIMITATION  
 14.1 POWER LIMITATION

15 INPUT DEFINE(M1M2)  
 15.1 M1M2  
 15.2 SMART GRID  
 15.3 Tw2  
 15.4 Tbt1  
 15.5 Tbt2  
 15.6 Ta  
 15.7 Ta-adj  
 15.8 SOLAR INPUT  
 15.9 F-PIPE LENGTH  
 15.10 RT/Ta\_PCB  
 15.11 PUMP\_I SILENT MODE  
 15.12 DFT1/DFT2

1 DHW MODE SETTING  
 1.1 DHW MODE  
 1.2 DISINFECT  
 1.3 DHW PRIORITY  
 1.4 PUMP\_D  
 1.5 DHW PRIORITY TIME SET  
 1.6 dT5\_ON  
 1.7 dT1S5  
 1.8 T4DHWMAX  
 1.9 T4DHWMIN  
 1.10 t\_INTERVAL\_DHW  
 1.11 dT5\_TBH\_OFF  
 1.12 T4\_TBH\_ON  
 1.13 t\_TBH\_DELAY  
 1.14 T5S\_DISINFECT  
 1.15 t\_DI\_HIGHTEMP  
 1.16 t\_DI\_MAX  
 1.17 t\_DHWHP\_RESTRICT  
 1.18 t\_DHWHP\_MAX  
 1.19 PUMP\_D TIMER  
 1.20 PUMP\_D RUNNING TIME  
 1.21 PUMP\_D DISINFECT RUN

3 HEAT MODE SETTING  
 3.1 HEAT MODE  
 3.2 t\_T4\_FRESH\_H  
 3.3 T4HMAX  
 3.4 T4HMIN  
 3.5 dT1SH  
 3.6 dTSH  
 3.7 t\_INTERVAL\_H  
 3.8 T1SetH1  
 3.9 T1SetH2  
 3.10 T4H1  
 3.11 T4H2  
 3.12 ZONE1 H-EMISSION  
 3.13 ZONE2 H-EMISSION  
 3.14 t\_DELAY\_PUMP

16 CASCADE SET  
 16.1 PER\_START  
 16.2 TIME\_ADJUST  
 16.3 ADDRESS RESET

17 HMI ADDRESS SET  
 17.1 HMI SET  
 17.2 HMI ADDRESS FOR BMS  
 17.3 STOP BIT

Table1 The environment temperature curve of the low temperature setting for heating

T4	≤ -20	-19	-18	-17	-16	-15	-14	-13	-12	-11	-10	-9	-8	-7	-6	-5	-4	-3	-2	-1	0
1-T1S	38	38	38	38	38	37	37	37	37	37	37	36	36	36	36	36	36	35	35	35	35
2-T1S	37	37	37	37	37	36	36	36	36	36	36	35	35	35	35	35	35	34	34	34	34
3-T1S	36	36	36	35	35	35	35	35	35	34	34	34	34	34	34	33	33	33	33	33	33
4-T1S	35	35	35	34	34	34	34	34	34	33	33	33	33	33	33	32	32	32	32	32	32
5-T1S	34	34	34	33	33	33	33	33	33	32	32	32	32	32	32	31	31	31	31	31	31
6-T1S	32	32	32	32	31	31	31	31	31	31	31	31	30	30	30	30	30	30	30	30	29
7-T1S	31	31	31	31	30	30	30	30	30	30	30	30	29	29	29	29	29	29	29	29	28
8-T1S	29	29	29	29	28	28	28	28	28	28	28	28	27	27	27	27	27	27	27	27	26
T4	1	2	3	4	5	6	7	8	9	10	11	12	13	14	15	16	17	18	19	≥ 20	
1-T1S	35	35	34	34	34	34	34	34	33	33	33	33	33	33	32	32	32	32	32	32	32
2-T1S	34	34	33	33	33	33	33	33	32	32	32	32	32	32	31	31	31	31	31	31	31
3-T1S	32	32	32	32	32	32	31	31	31	31	31	31	30	30	30	30	30	30	29	29	29
4-T1S	31	31	31	31	31	31	30	30	30	30	30	30	29	29	29	29	29	29	28	28	28
5-T1S	30	30	30	30	30	30	29	29	29	29	29	29	28	28	28	28	28	28	27	27	27
6-T1S	29	29	29	29	29	29	28	28	28	28	28	28	27	27	27	27	27	27	26	26	26
7-T1S	28	28	28	28	28	28	27	27	27	27	27	27	26	26	26	26	26	26	25	25	25
8-T1S	26	26	26	26	26	26	26	25	25	25	25	25	25	25	25	24	24	24	24	24	24

Table2 The environment temperature curve of the high temperature setting for heating

T4	≤ -20	-19	-18	-17	-16	-15	-14	-13	-12	-11	-10	-9	-8	-7	-6	-5	-4	-3	-2	-1	0
1-T1S	55	55	55	55	54	54	54	54	54	54	54	54	53	53	53	53	53	53	53	53	52
2-T1S	53	53	53	53	52	52	52	52	52	52	52	52	51	51	51	51	51	51	51	51	50
3-T1S	52	52	52	52	51	51	51	51	51	51	51	51	50	50	50	50	50	50	50	50	49
4-T1S	50	50	50	50	49	49	49	49	49	49	49	49	48	48	48	48	48	48	48	48	47
5-T1S	48	48	48	48	47	47	47	47	47	47	47	47	46	46	46	46	46	46	46	46	45
6-T1S	45	45	45	45	44	44	44	44	44	44	44	44	43	43	43	43	43	43	43	43	42
7-T1S	43	43	43	43	42	42	42	42	42	42	42	42	41	41	41	41	41	41	41	41	40
8-T1S	40	40	40	40	39	39	39	39	39	39	39	39	38	38	38	38	38	38	38	38	37
T4	1	2	3	4	5	6	7	8	9	10	11	12	13	14	15	16	17	18	19	≥ 20	
1-T1S	52	52	52	52	52	52	52	51	51	51	51	51	51	51	51	50	50	50	50	50	50
2-T1S	50	50	50	50	50	50	50	49	49	49	49	49	49	49	49	48	48	48	48	48	48
3-T1S	49	49	49	49	49	49	49	48	48	48	48	48	48	48	48	47	47	47	47	47	47
4-T1S	47	47	47	47	47	47	47	46	46	46	46	46	46	46	46	45	45	45	45	45	45
5-T1S	45	45	45	45	45	45	45	44	44	44	44	44	44	44	44	43	43	43	43	43	43
6-T1S	42	42	42	42	42	42	42	41	41	41	41	41	41	41	41	40	40	40	40	40	40
7-T1S	40	40	40	40	40	40	40	39	39	39	39	39	39	39	39	38	38	38	38	38	38
8-T1S	37	37	37	37	37	37	37	36	36	36	36	36	36	36	36	35	35	35	35	35	35

The automatic setting curve

The automatic setting curve is the ninth curve, this is the calculation:

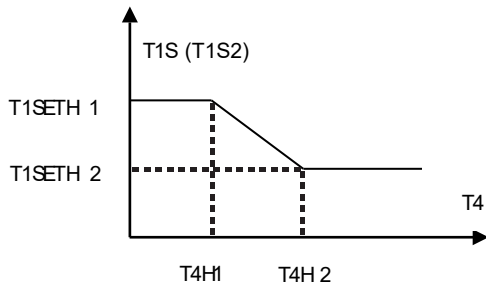

State: In the setting the wired controller, if  $T4H2 < T4H1$ , then exchange their value; if  $T1SETH1 < T1SETH2$ , then exchange their value.

Table3 The environment temperature curve of the low temperature setting for cooling

T4	$-10 \leq T4 < 15$	$15 \leq T4 < 22$	$22 \leq T4 < 30$	$30 \leq T4$
1- T1S	16	11	8	5
2- T1S	17	12	9	6
3- T1S	18	13	10	7
4- T1S	19	14	11	8
5- T1S	20	15	12	9
6- T1S	21	16	13	10
7- T1S	22	17	14	11
8- T1S	23	18	15	12

Table4 The environment temperature curve of the high temperature setting for cooling

T4	- 10≤ T4< 15	15≤ T4<22	22≤ T4<30	30≤ T4
1- T1S	20	18	17	16
2- T1S	21	19	18	17
3- T1S	22	20	19	17
4- T1S	23	21	19	18
5- T1S	24	21	20	18
6- T1S	24	22	20	19
7- T1S	25	22	21	19
8- T1S	25	23	21	20

The automatic setting curve

The automatic setting curve is the ninth curve, this is the calculation:

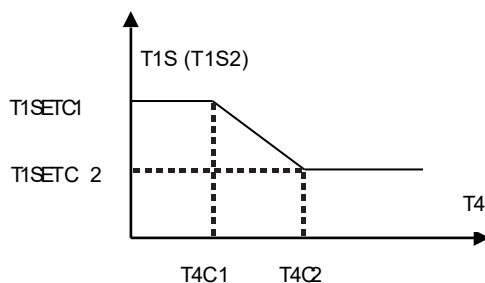

State: In the setting the wired controller, if  $T4C2 < T4C1$ , then exchange their value; if  $T1SETC1 < T1SETC2$ , then exchange their value.









Different languages

16110600A05996 V1.0

Importer:  
F.G. EUROPE S.A.  
128, Vouliagmenis Ave.  
GR-166 74 Glyfada - Athens, Greece  
Manufacturer:  
GD Midea Heating & Ventilating  
Equipment Co.,Ltd.  
Penglai Industry Road,Beijiao,  
Shunde, Foshan,  
Guangdong,528311,P.R.China



## 印刷技术要求

材质	80g双胶纸
规格	210*297(双面)
颜色	黑白
其他	/

## 设计更改记录 (仅做说明用, 不做菲林)

版本升级	更改人	更改日期	更改主要内容	涉及更改页面 (印刷页码)